



Putzmeister

Stationary concrete pump

BSA 1006 D5 BSA 1006 E

Output up to 64 m³/h
Delivery pressure up to 55 bar

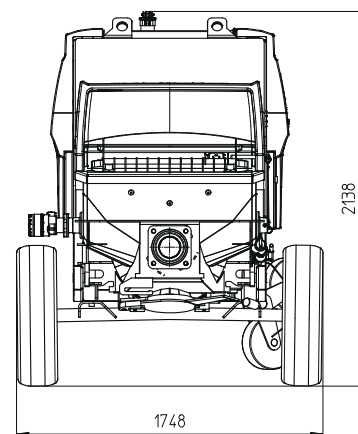
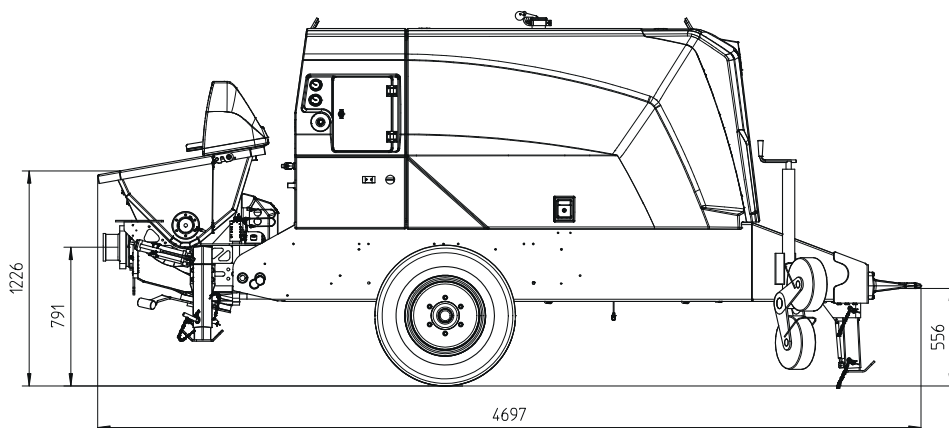

Dimensions and weights depend on equipment. Subject to technical modifications and errors.

Technical data

Model		BSA 1006 D5	BSA 1006 E
Material number		102684.000	102685.000
Output	m ³ /h	64	59
Delivery pressure	bar	55	
Delivery cylinder	Ø mm	180	
Delivery cyl. stroke	mm	1000	
Strokes / minute		42	38
Engine / motor power	kW	55.4	45
Hopper		RS 488	
Capacity	l	approx. 300	
Filling height	m	1.23	
Transfer tube		S 1812	
Line connection	mm	SK 125	
Pressure connection	"	5.5	
Control system		Ergonic 3 PS	
Diesel tank	l	120	–
Weight	kg	2900	3100

Serial equipment

Agitator safety switch off	Grill 60 mm
Cable remote control 10 m	Operating manuals (1× paper, 1× CD-ROM) spare part list
Central lubrication on hopper with grease gun	Output adjustment, electrical
Chassis F8	Outriggers 3× mech.
Cleaning accessories	Speed drawdown automatically on pump stop (Diesel driven only)
Coloring: Pump, frame, roof anthracite-grey Doors chrome yellow	Splash guard
Concrete hopper with agitator	Support wheel
Drive diesel, Deutz 55.4 kW, Stage 5 (1006 D5)	Tool set incl. standard equipment
Drive electric, 45 kW, iE03 (1006 E)	Tow coupler, DIN eye
Electronic error management	
Ergonic Graphic Display	
Flushing water pump 50 l/min 20 bar	

All data maximum theoretical

See quotation for exact serial delivery scope.
Comprehensive range of options available on request.